

21. September 2020

## anti-flooding valve Stausafe H, DN 150

Product No. **661197**  
EAN: 4001636661197  
Discount group: 3

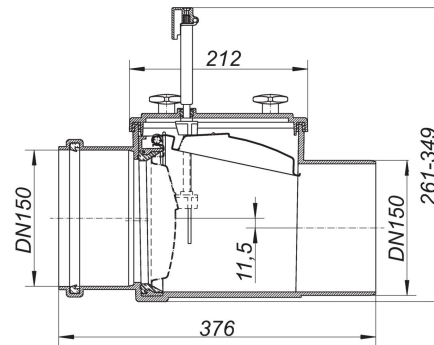
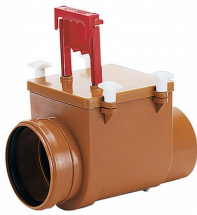

for use with rain water systems

specification:

- self-closing stainless steel flap
- manually operated lock
- stainless steel pivots
- easy to maintain ABS housing
- inspection cover with wingnuts can be opened for maintenance without tools